

EMPowered™



Exterior Projection: 3/4"



Interior Projection: 1 1/2"
Projection with Thumbturn: 2 1/8"

EMPowered™ Product Features:

- Standard door prep 2 1/8" bore.
- Fits standard door thickness of 1 1/2" to 2 1/4".
- Complete set includes both 2 3/8" and 2 3/4" latches, strike plates and 4 AA batteries.
- EMPowered Deadbolt only available with square corner latch face plate.
- Tapered Deadbolt
- Emtek's standard mechanical and finish warranties along with a 1 year warranty on electronic components.

BACKLIT KEYPAD - Keypad wakes with a touch and includes numbers that won't wear off.

OPTIONAL SETTINGS - Customized auto re-lock, privacy mode and tamper alarms with the lock settings.

MOTORIZED DEADBOLT - Quiet motor with tapered deadbolt to accommodate misaligned doors.

SIMPLE INSTALLATION - Replaces existing deadbolt with just a screwdriver.

WEATHER PROTECTED - Rubber gasket increases protection against outdoor environments.

MANAGE CODES - Create up to 25 user PIN codes to share with friends and family. Unlimited codes with Yale Access App.

EMPowered™ SMART Lock Features:

CONTROL FROM ANYWHERE - Includes the Yale Connect Wi-Fi Bridge so you can lock and unlock from anywhere using your Yale Access app.

SHARE ACCESS - Grant access to your home for the people you trust. Give permanent/temporary access or set a unique access schedule.

24/7 HISTORY - See who comes and goes with smartphone notifications and a 24/7 access history in the app.

USE YOUR VOICE - Works with the three leading voice assistants; Amazon Alexa, Google Assistant and Siri.

COMES WITH DOORSENSE™ - Know if your door is not only locked or unlocked but also closed or opened.

AUTO-LOCK - Never worry if your door is locked again. Auto-Lock can be set for immediate or on a timer for as short as 30 sec or as long as 30 min.

AUTO UN-LOCK - Auto-Unlock knows when you arrive and unlocks the door as you approach. Never fumble for keys again.

EMTOUCH™

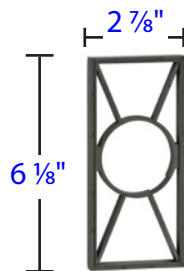

Adaptors available for leversets to fit doors between 1 3/8" and 1 5/8" thick.

Product Features:

- Fits any door between 1 3/4" to 2 1/4" thick with a 2 1/8" bore standard door prep.
- Installs easily with only a Phillips head screwdriver.
- Easy to use installation and programming instructions included.
- Factory programmed with 2 unique, secure user codes for use right out of the box.
- Can be programmed with up to 20 user codes of your choice.
- Codes can be added and deleted.
- Easy lock operation, simply push the Emtek button and turn the exterior thumb turn to lock.
- Easy unlock operation, enter the 4 digit code and turn the exterior thumb turn.
- Programming changes can be made easily using the keypad.
- Sleek keypad has a protective coating to prevent wear patterns.
- Illuminated keypad for easy and quick operation after dark.
- Low battery indicator lets you know when it's time to change the battery.
- Emtek's standard mechanical and finish warranties along with a 2 year warranty on electronic components.

EMTOUCH™

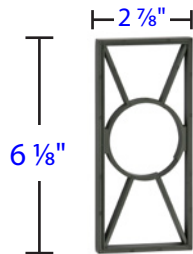
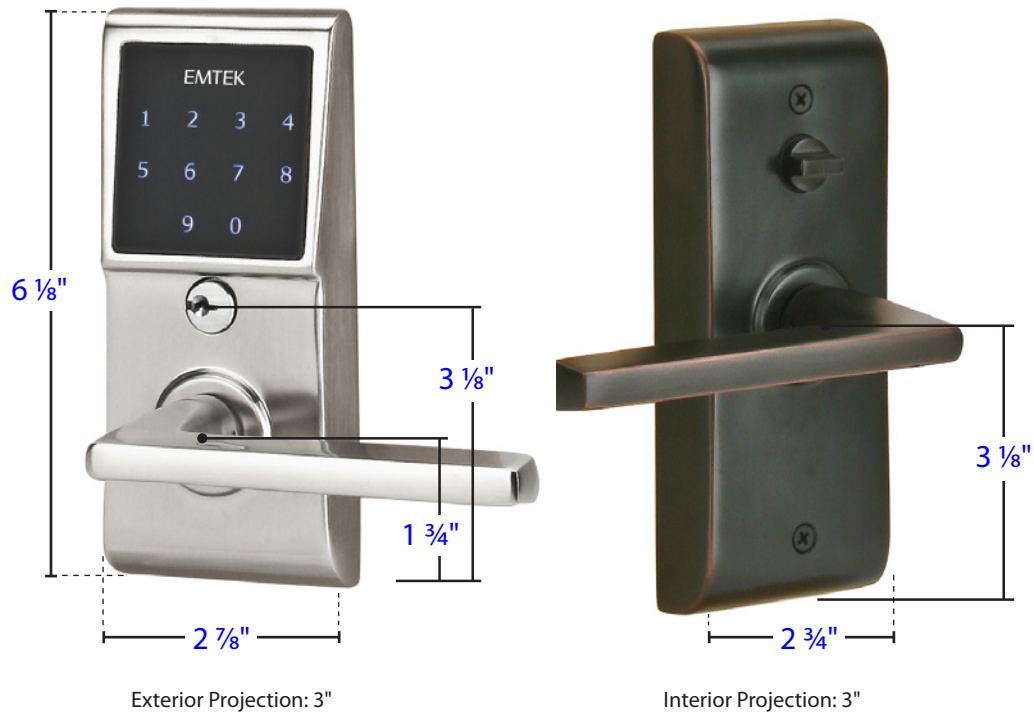

Adaptors available for leversets to fit doors between 1 3/8" and 1 5/8" thick.



Passage Function Shown in Passage Mode

Storeroom/Gate Function



- Storeroom / Gate Function**
- Outside lever always locked
 - Entry by code or key only
 - Inside lever always free



Passage Function in Locked Mode

- Outside lever always locked
- Entry by code or key only
- Inside lever always free



Passage Function in Passage Mode

- Outside lever always free
- Entry by operating lever, no code or key required.
- Inside lever always free

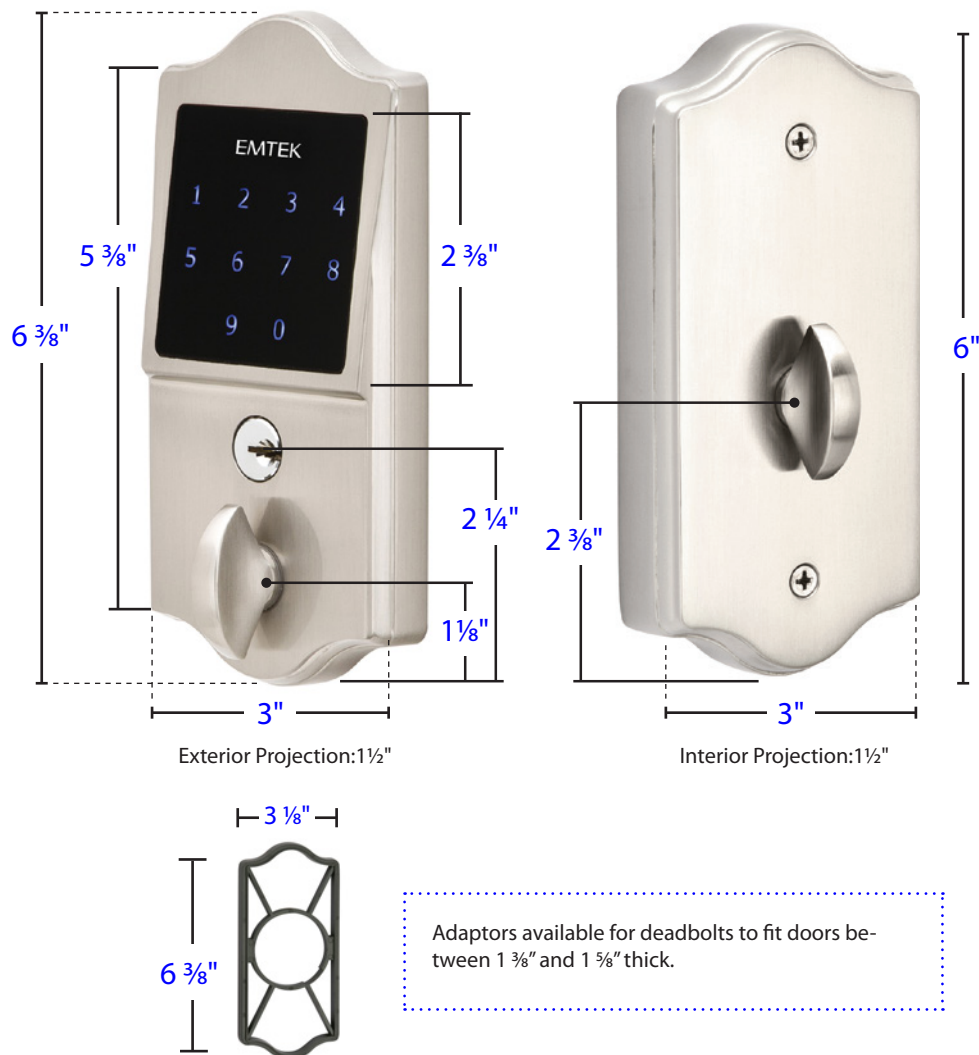
EMTOUCH™ CLASSIC

Product Features:

- Fits any door between 1 3/4" to 2 1/4" thick with a 2 1/8" bore standard door prep.
- Installs easily with only a Phillips head screwdriver.
- Easy to use installation and programming instructions included.
- Factory programmed with 2 unique, secure user codes for use right out of the box.
- Can be programmed with up to 20 user codes of your choice.
- Codes can be added and deleted.
- Easy lock operation, simply push the Emtek button and turn the exterior thumb turn to lock.
- Easy unlock operation, enter the 4 digit code and turn the exterior thumb turn.
- Programming changes can be made easily using the keypad.
- Sleek keypad has a protective coating to prevent wear patterns.
- Illuminated keypad for easy and quick operation after dark.
- Low battery indicator lets you know when it's time to change the battery.
- Emtek's standard mechanical and finish warranties along with a 2 year warranty on electronic components.

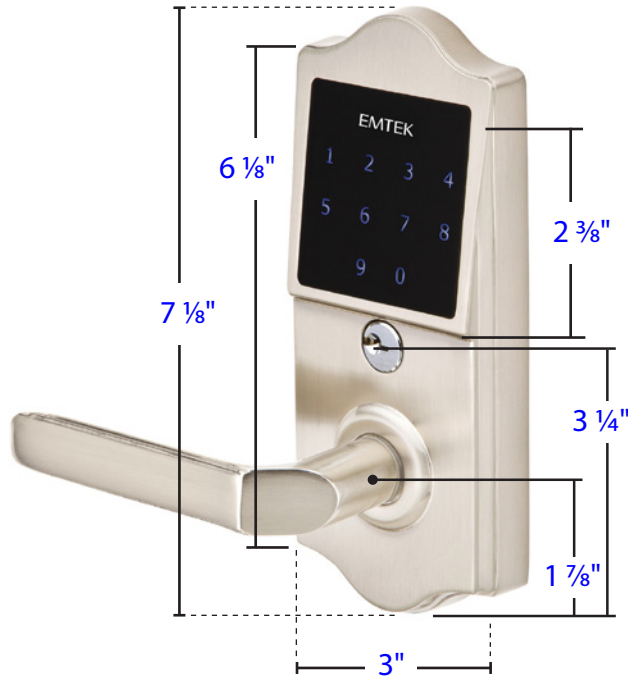
EMTOUCH™ CLASSIC

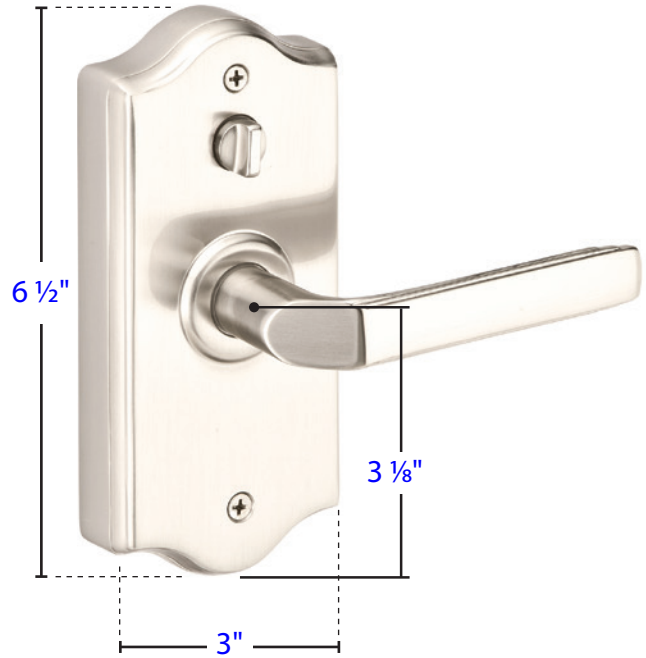

Exterior Projection: 3 1/4"



Interior Projection: 3 1/8"

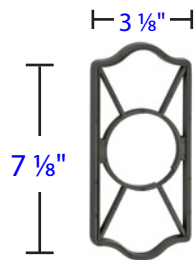

Adaptors available for leversets to fit doors between 1 3/8" and 1 5/8" thick.



Passage Function
 Shown in Passage
 Mode

Storeroom/Gate
 Function



- Storeroom / Gate Function**
- Outside lever always locked
 - Entry by code or key only
 - Inside lever always free



Passage Function in Locked Mode

- Outside lever always locked
- Entry by code or key only
- Inside lever always free



Passage Function in Passage Mode

- Outside lever always free
- Entry by operating lever, no code or key required.
- Inside lever always free

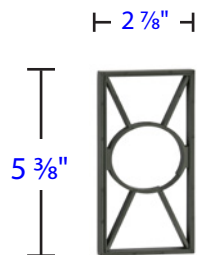
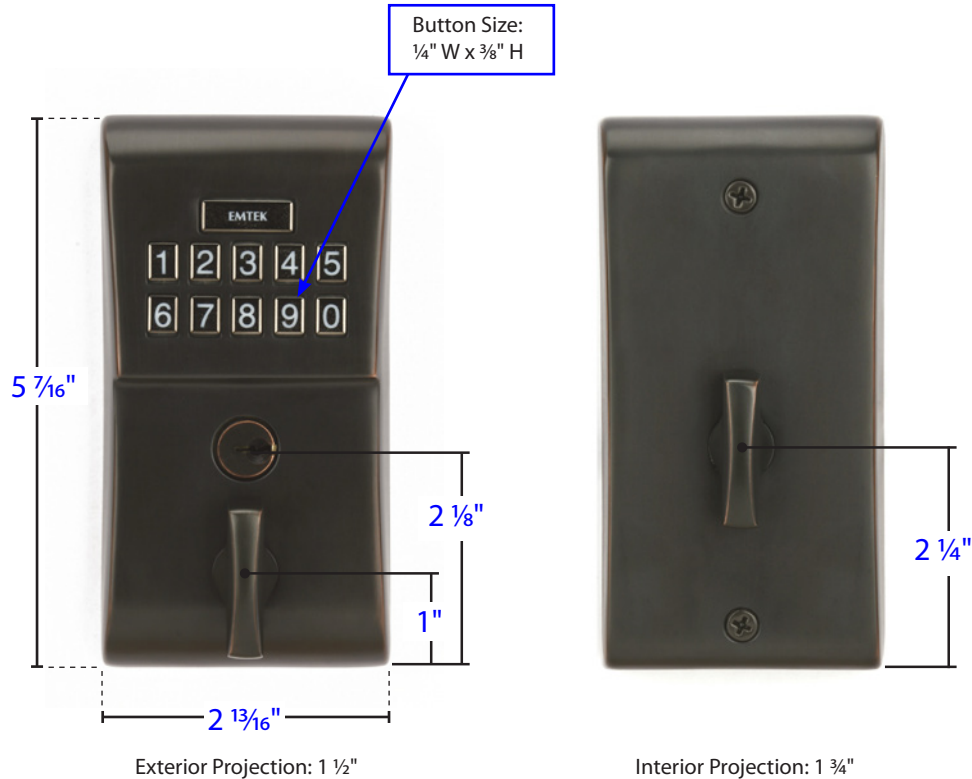

Adaptors available for deadbolts to fit doors between 1 3/8" and 1 5/8" thick.

Product Features:

- Fits any door between 1 3/4" to 2 1/4" thick with a 2 7/8" bore standard door prep.
- Installs easily with only a Phillips head screwdriver.
- Easy to use installation and programming instructions included.
- Factory programmed with 2 unique, secure user codes for use right out of the box.
- Can be programmed with up to 20 user codes of your choice.
- Codes can be added and deleted.
- Easy lock operation, simply push the Emtek button and turn the exterior thumb turn to lock.
- Easy unlock operation, enter the 4 digit code and turn the exterior thumb turn.
- Programming changes can be made easily using the keypad.
- Sleek keypad has a protective coating to prevent wear patterns.
- Illuminated keypad for easy and quick operation after dark.
- Low battery indicator lets you know when it's time to change the battery.
- Emtek's standard mechanical and finish warranties along with a 2 year warranty on electronic components.

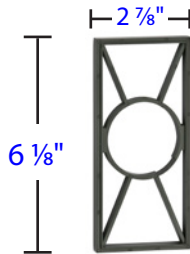
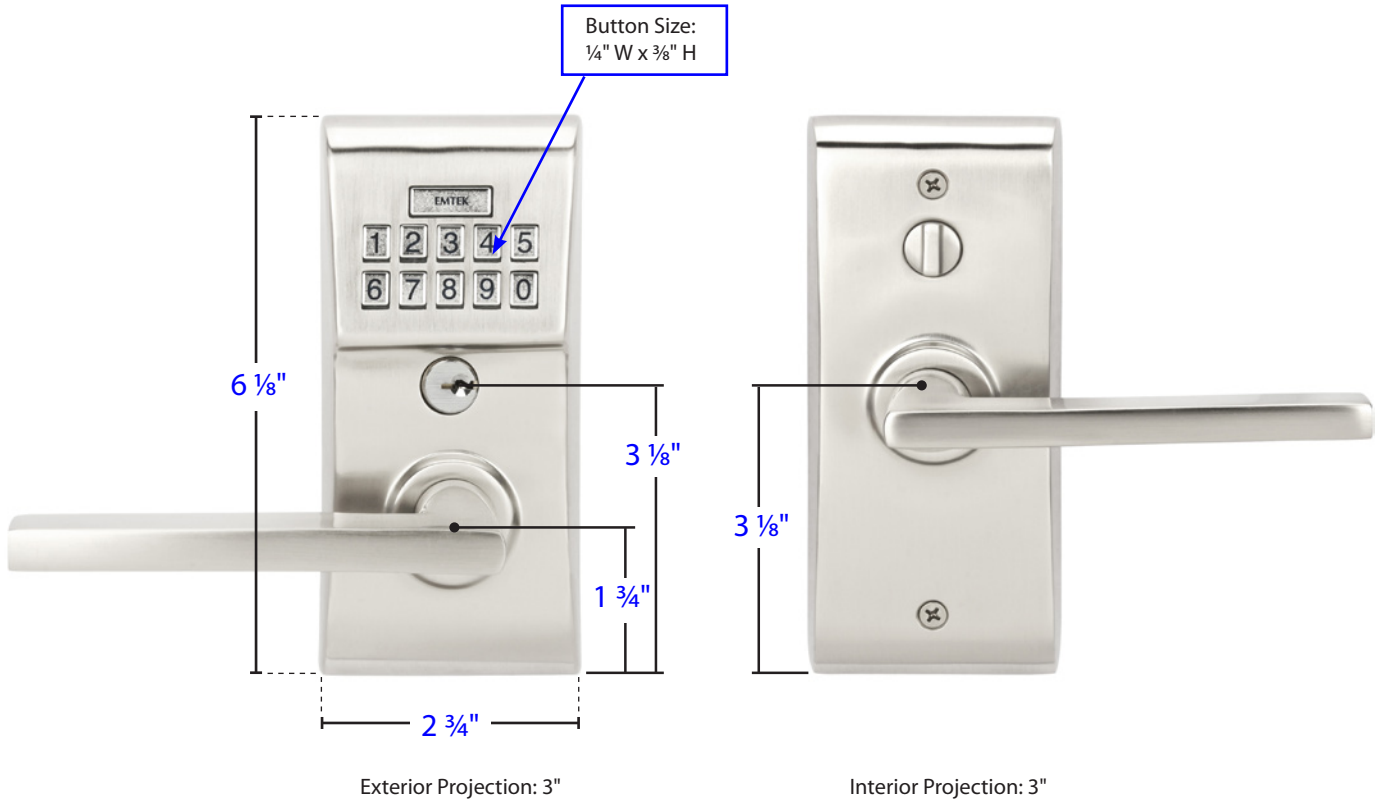

Adaptors available for leversets to fit doors between 1 ⅜" and 1 ⅝" thick.



Passage Function Shown in Passage Mode

Storeroom/Gate Function



- Storeroom / Gate Function**
- Outside lever always locked
 - Entry by code or key only
 - Inside lever always free



- Passage Function in Locked Mode**
- Outside lever always locked
 - Entry by code or key only
 - Inside lever always free



- Passage Function in Passage Mode**
- Outside lever always free
 - Entry by operating lever, no code or key required.
 - Inside lever always free

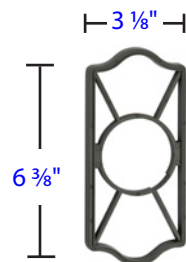
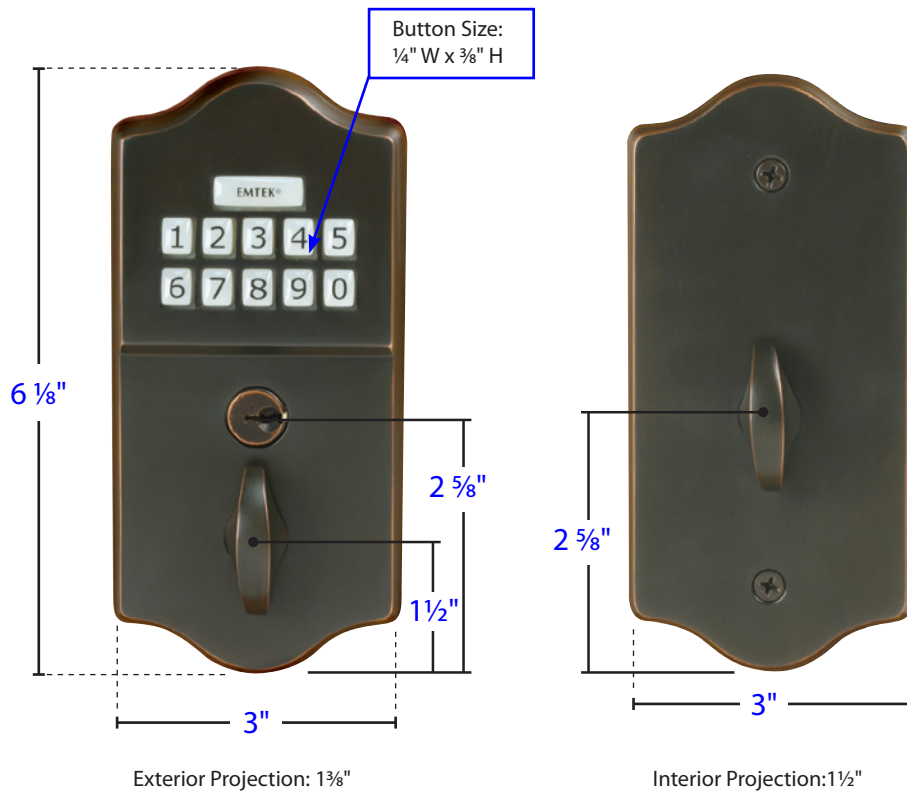

Adaptors available for deadbolts to fit doors between 1 3/8" and 1 5/8" thick.

Product Features:

- Fits any door between 1 3/4" to 2 1/4" thick with a 2 1/8" bore standard door prep.
- Installs easily with only a Phillips head screwdriver.
- Easy to use installation and programming instructions included.
- Factory programmed with 2 unique, secure user codes for use right out of the box.
- Can be programmed with up to 20 user codes of your choice.
- Codes can be added and deleted.
- Easy lock operation, simply push the Emtek button and turn the exterior thumb turn to lock.
- Easy unlock operation, enter the 4 digit code and turn the exterior thumb turn.
- Programming changes can be made easily using the keypad.
- Keypad has a protective coating to prevent wear patterns.
- Illuminated keypad for easy and quick operation after dark.
- Low battery indicator lets you know when it's time to change the battery.
- Emtek's standard mechanical and finish warranties along with a 2 year warranty on electronic components.

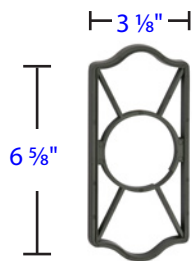
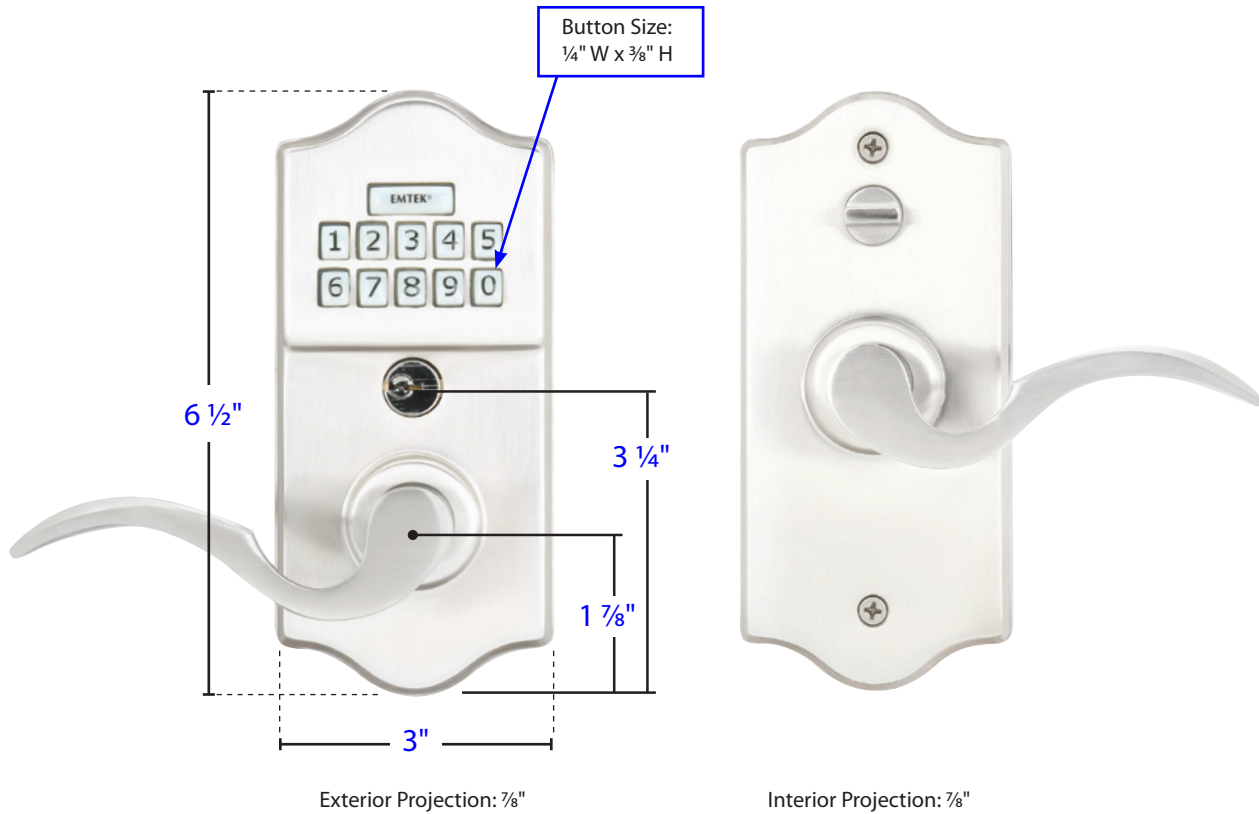

Adaptors available for leversets to fit doors between 1 3/8" and 1 5/8" thick.

Product Features for both Deadbolt & Lever Locksets:

- Fits any door between 1 3/4" to 2 1/4" thick with a 2 1/8" bore standard door prep.
- Installs easily with only a Phillips head screwdriver.
- Easy to use installation and programming instructions included.
- Factory programmed with 2 unique, secure user codes for use right out of the box.
- Can be programmed with up to 20 user codes of your choice.
- Programming changes can be made easily using the keypad.
- Keypad has a protective coating to prevent wear patterns.
- Illuminated keypad for easy and quick operation after dark.
- Low battery indicator lets you know when it's time to change the battery.
- Emtek's standard mechanical and finish warranties along with a 2 year warranty on electronic components.

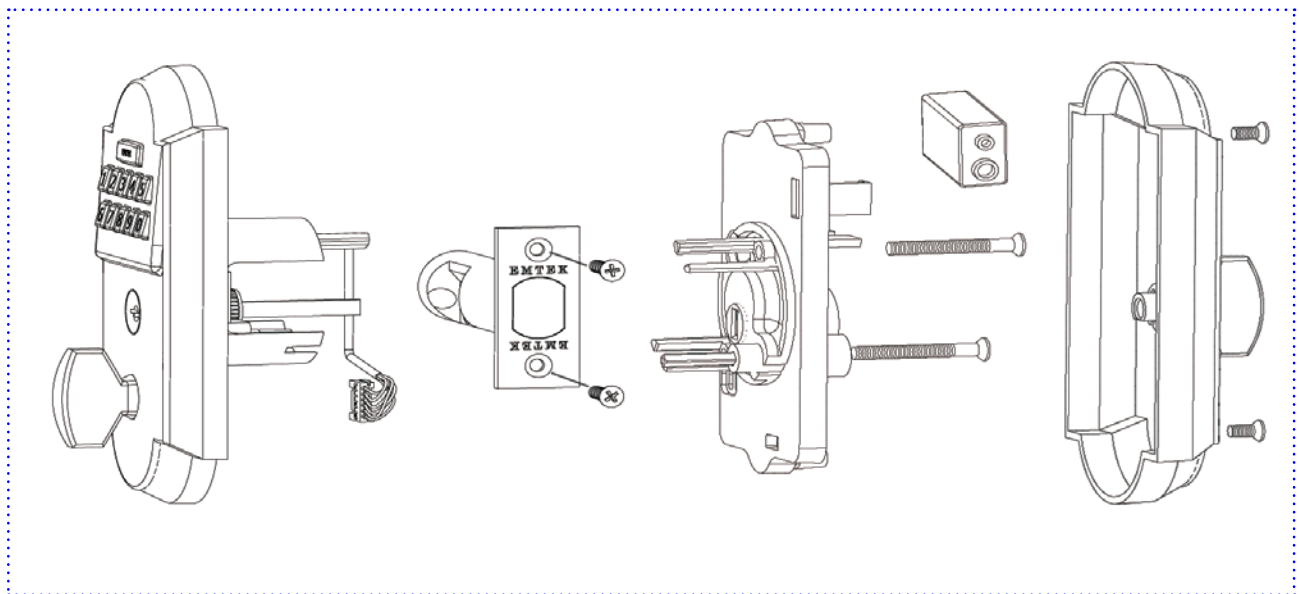
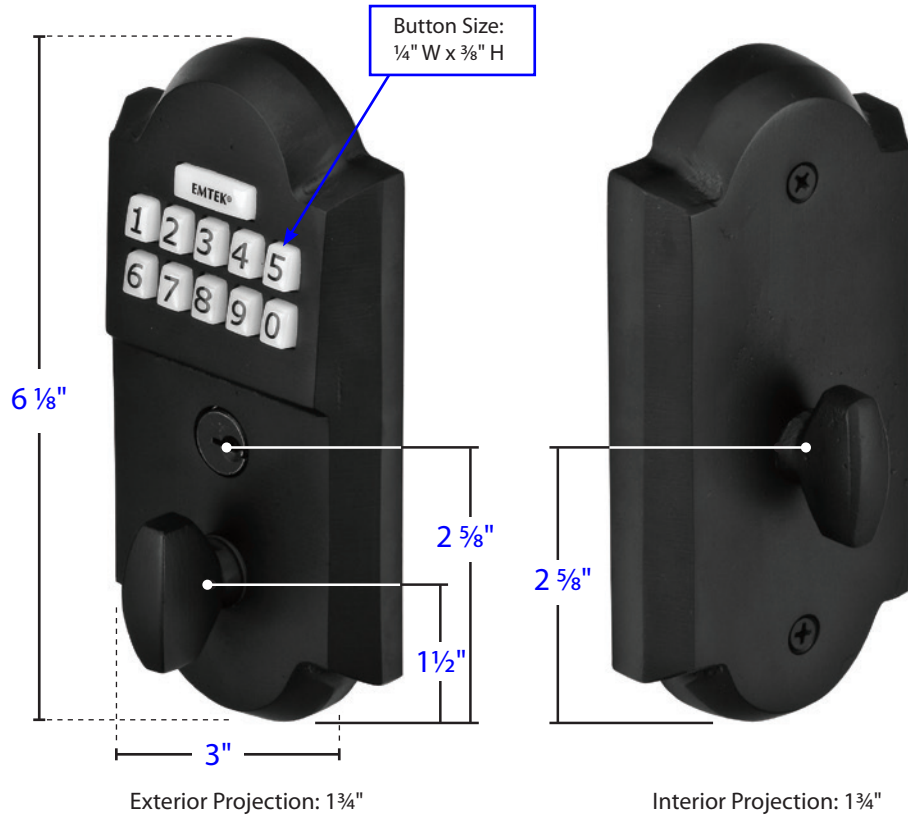

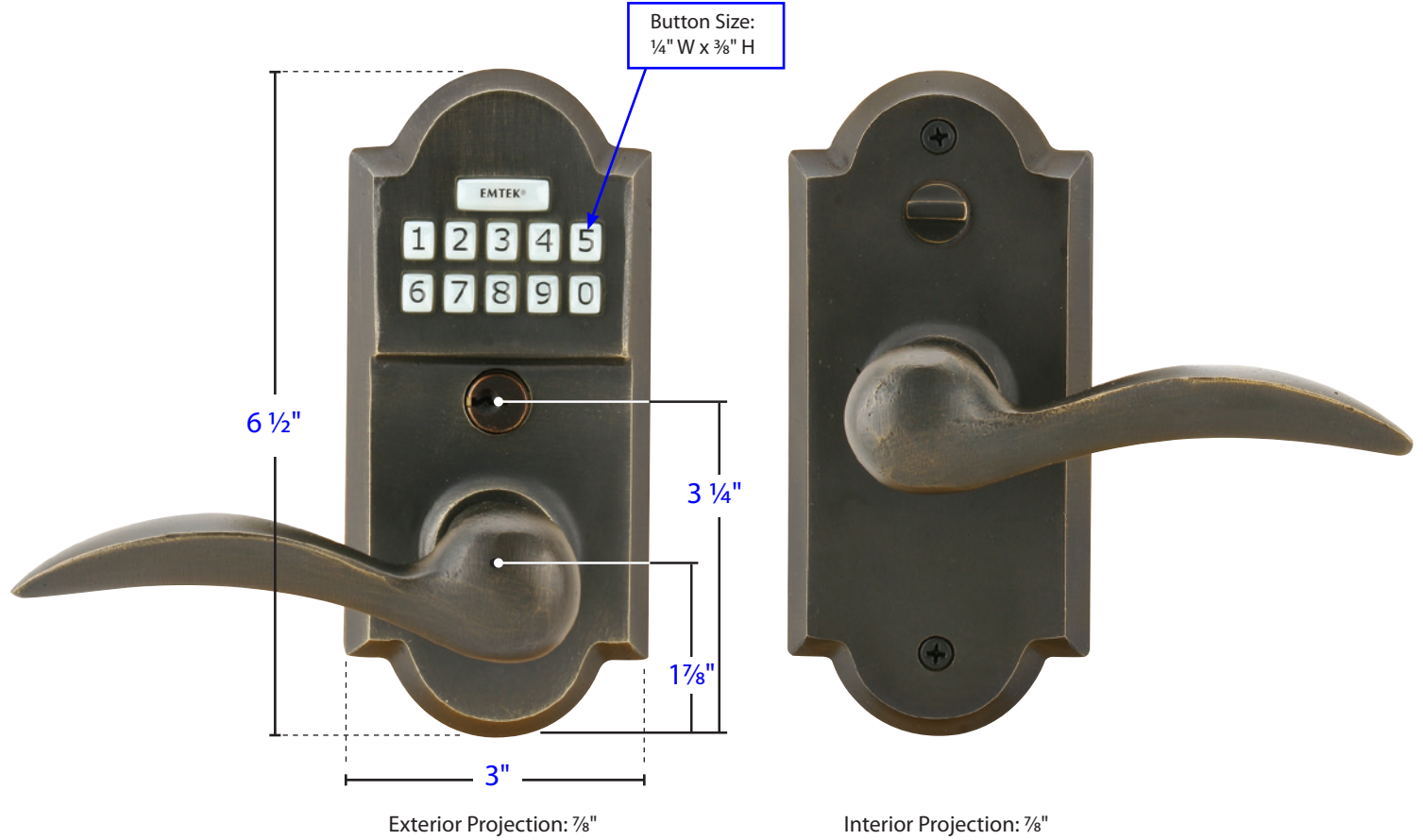

Shown in Passage Mode *Storeroom/Gate Function*

Storeroom / Gate Function

- Outside lever always locked
- Entry by code or key only
- Inside lever always free

Locked

- Outside lever always locked
- Entry by code or key only
- Inside lever always free

Passage

- Outside lever always free
- Entry by operating lever, no code or key required.
- Inside lever always free

EMTouch™ Modern, Classic Keypad Locks
Deadbolt

- Standard Door Thickness: 1 3/4" - 2 1/4"
- Standard Components:
- 8-32 x 1 1/2" Mounting Screws
- Schlage Cylinder w/ 1 1/2" Tailpiece
- Deadbolt Strike Plate

- **Narrow** Door Thickness: 1 3/8" - 1 5/8"
- Narrow Components:
- Extension Plate**

- **Extended** Door Thickness: Greater than 2 1/4"
- Extended Components:
- Not Available

**Extension Plate is not available with bronze trim

EMTouch™ Modern, Classic Keypad Locks
Leverset

- Standard Door Thickness: 1 3/4" - 2 1/4"
- Standard Components:
- 8-32 x 1 1/2" Mounting Screws
- Schlage Cylinder w/ 3/8" Lever Lock Tailpiece
- Full-Lip Strike Plate*

- **Narrow** Door Thickness: 1 3/8" - 1 5/8"
- Narrow Components:
- Extension Plate**

- **Extended** Door Thickness: Greater than 2 1/4"
- Extended Components:
- Not Available

*Extended Full Lip Strike Plate is used on doors greater than 2" thick

**Extension Plate is not available with bronze trim