

Hercules Smooth Pull (86480)

Projection: 2 1/4"
A= 8 5/8"
Base: 5/8" x 3/4"

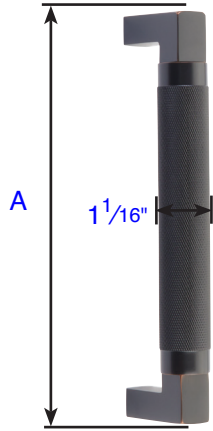

Hercules Knurled Pull (86481)

Projection: 2 1/4"
A= 8 5/8"
Base: 5/8" x 3/4"

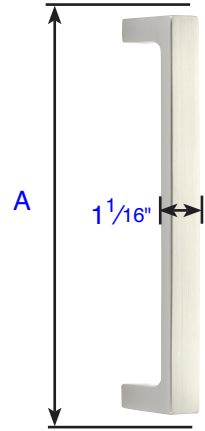

Brisbane Pull (86170)

Projection: 1 13/16"
A= 8 9/16"
Base: 13/16" x 9/16"

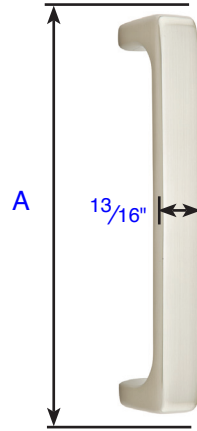

Baden Pull (86184)
Stainless Steel &
Baden Pull (S86002)

Projection: 2 1/8"
A= 8 5/8"
Base: 1" x 1/16"

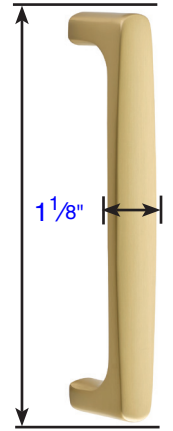

Urban Modern Pull (86176)

Projection: 1 7/8"
A= 8 5/8"
Base: 7/8" x 3/4"

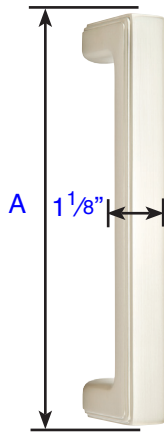

Wilshire Pull (86078)

Projection: 2 1/8"
A= 8 7/8"
Base: 1 1/8" Diameter

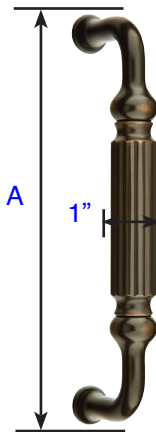

Knoxville Pull (86077)

Projection: 2 1/2"
A= 8 13/16"
Base: 3/4" Diameter

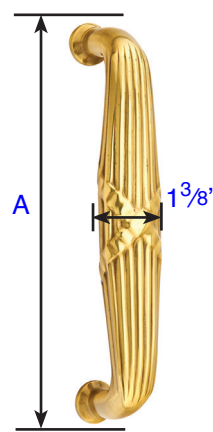

Ribbon & Reed Pull (86080)

Projection: 2 3/8"
A= 8 15/16"
Base: 1" Diameter

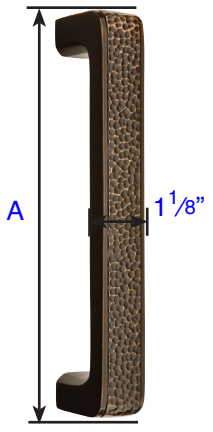

Arts & Crafts Pull (86079)

Projection: 2 1/8"
A= 8 7/8"
Base: 1 1/8" Diameter

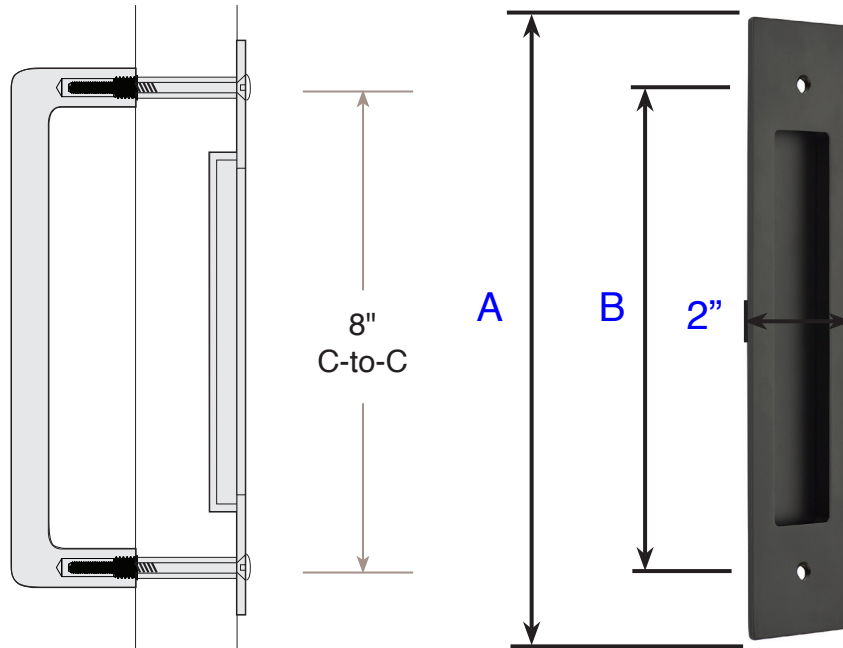

Drilled to accept 8" pull

Thickness: $\frac{3}{8}$ "
A= 10"
B= 8" Screw-to-Screw

Modern Rectangular
Flush Pull
for Door Pull
(221710)
Flush Pull Only

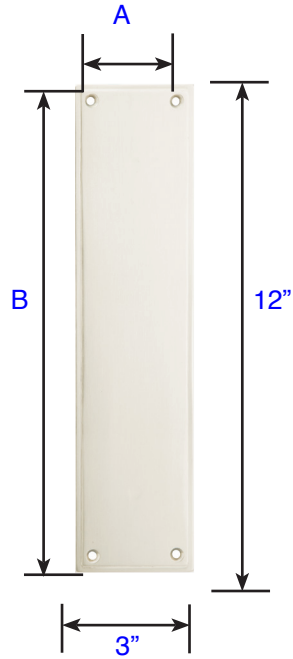

Modern Push Plate
(86436)

A= 2¹/₈" Screw-to-Screw
B= 11¹/₈" Screw-to-Screw

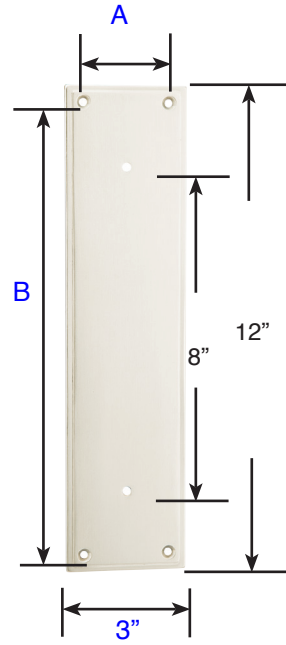

Modern Pull Plate (86437)
Plate only
Drilled to accept 8" pull

A= 2¹/₈" Screw-to-Screw
B= 11¹/₈" Screw-to-Screw

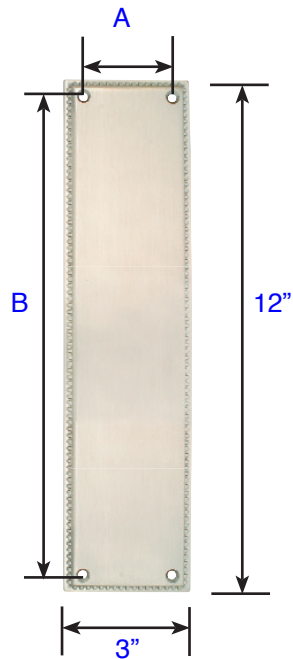

Knoxville Push (86081)
Plate

A= 2¹/₈" Screw-to-Screw
B= 11¹/₈" Screw-to-Screw

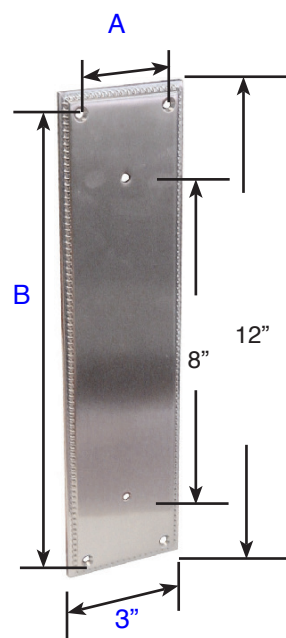

Knoxville Pull Plate (86082)
Plate only
Drilled to accept 8" pull

A= 2¹/₈" Screw-to-Screw
B= 11¹/₈" Screw-to-Screw

8 3/4" Screw-to-Screw

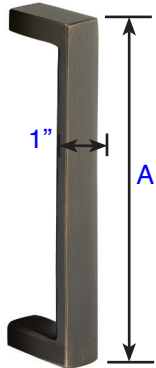

8 3/4"
Bronze Rustic
Modern Rectangular
(86180)

A = 9 1/2"
Projection: 2"
Base: 1" x 1 1/16"

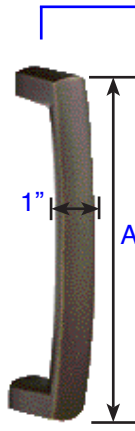

8"
Bronze Rustic
Modern Arched
(86439)

A = 8 1/2"
Projection: 2 1/2"
Base: 1 3/16"

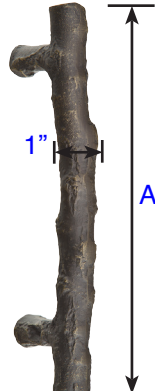

8"
Bronze Twig Pull
(86090)

A = 11"
Projection: 3"
Base Diameter: 7/8"

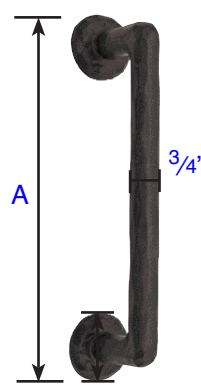

8"
Bronze Rod Pull
(86088)

A = 9 13/16"
Projection: 2 9/16"
Base Diameter: 1 13/16"

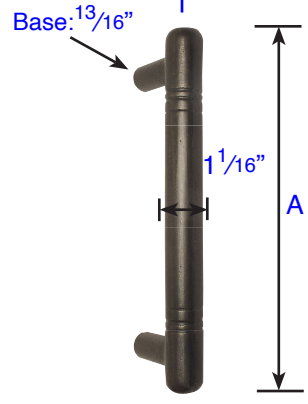

8"
Bronze Nunez Pull
(86160)

A = 9 7/8"
Projection: 2 3/4"
Clearance: 1 11/16"

Standard Components:

- 1", 10-32 Screws
- 1", 1/4"-20 Screws
- Inserts for 1/4"-20 screws
- Inserts for 10-32 screws

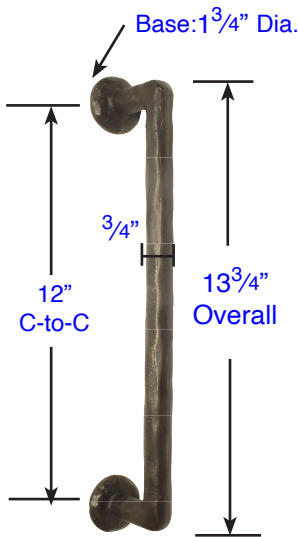

12"
Bronze Rod Pull
(86068)

Projection: 2 9/16"
Clearance: 1 3/4"

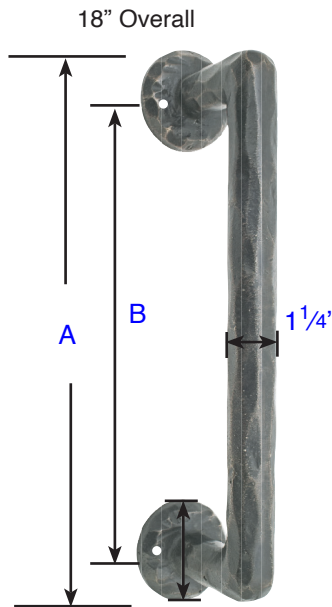

18"
Bronze Rod Pull
(86089)

A = 18" B = 15"
Projection: 3 3/16"
Base Diameter: 3"

Screw Specifications
Bronze 18" Pulls

- Standard Components:
- #10, 1" Wood Screws

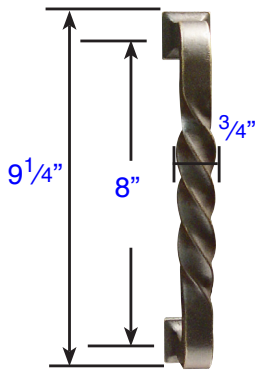

Tuscany 8" Twist Pull
(86069)

Projection: $2\frac{3}{4}$ "
Base = $1\frac{1}{4}$ "
Squared

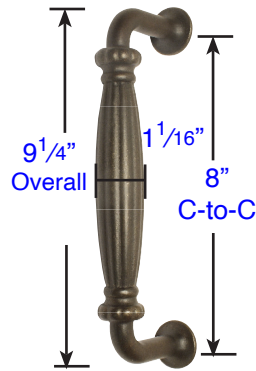

Tuscany 8" Palermo Pull
(86167)

Projection: $2\frac{13}{16}$ "
Clearance: $1\frac{3}{4}$ "
Base: $1\frac{1}{4}$ " Dia.

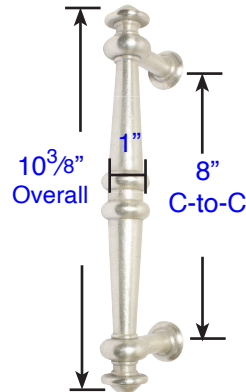

Tuscany 8" Recoleta Pull
(86168)

Projection: $2\frac{7}{8}$ "
Clearance: $1\frac{5}{8}$ "
Base: $1\frac{3}{16}$ "

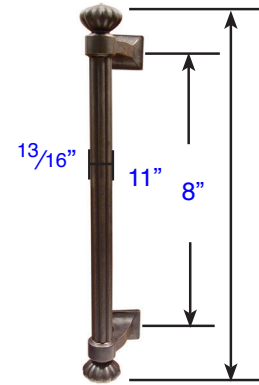

Tuscany 8" Column Pull
(86156)

Projection: 3"
Base = $1\frac{1}{4}$ "
Squared

**Screw Specifications
Tuscany Bronze 8" Pulls**

- Standard Components:
- 1", 10-32 Screws
 - 1", 1/4"-20 Screws

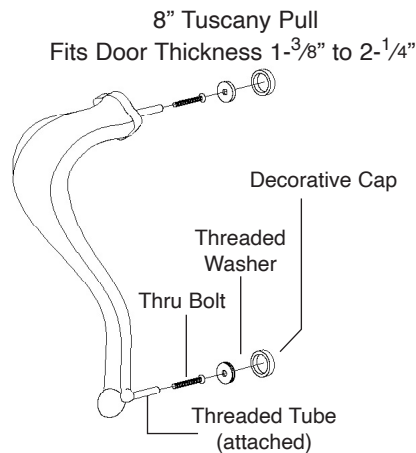

Screw Specifications
Art Nouveau 8" Pull
• $1\frac{1}{2}$ ", 8-32 Screws

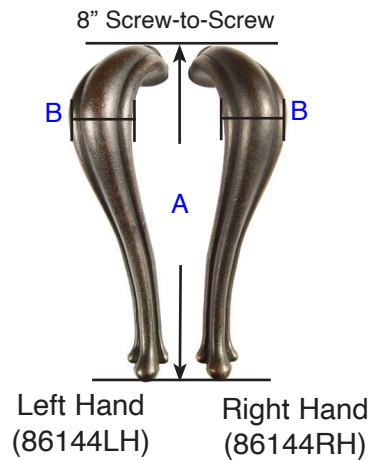

A = $9\frac{3}{16}$ " B = $1\frac{7}{16}$ "
Projection: $2\frac{1}{2}$ "

**Discontinued.
No Longer Available**

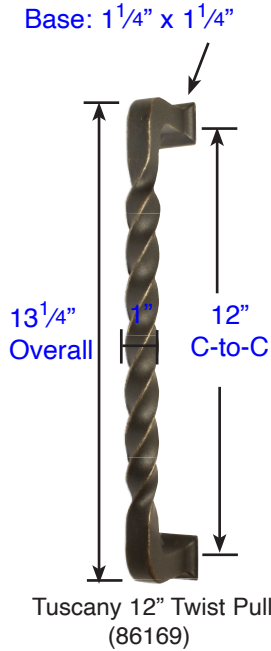

Projection: 2 3/4"
Clearance: 1 13/16"

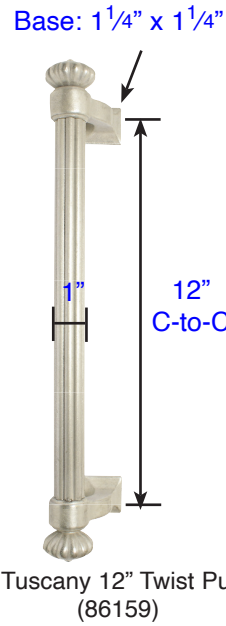

Projection: 3"
Clearance: 2"

**Discontinued.
No Longer Available**

Standard Components:

- 1", 10-32 Screws
- 1", 1/4"-20 Screws
- Inserts for 1/4"-20 screws
- Inserts for 10-32 screws

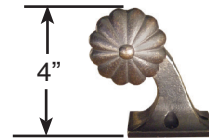
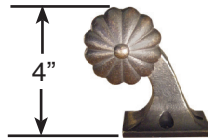

Tuscany 18" Column Pull (86157)
Supplied with #10 wood screws.

A = 13 7/16" Screw-to-Screw
Base = 2"L, 2 3/4"W

**Discontinued.
No Longer Available**

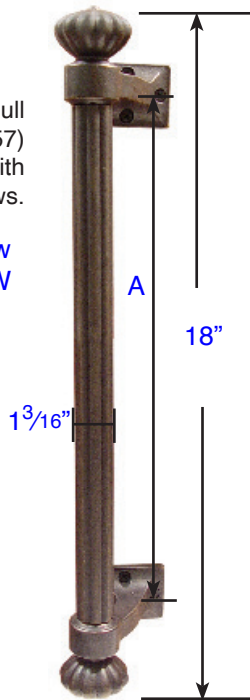

Tuscany 24" Column Pull (86158)
Supplied with #10 wood screws.

A = 19 7/16" Screw-to-Screw
Base = 2"L, 2 3/4"W

**Discontinued.
No Longer Available**

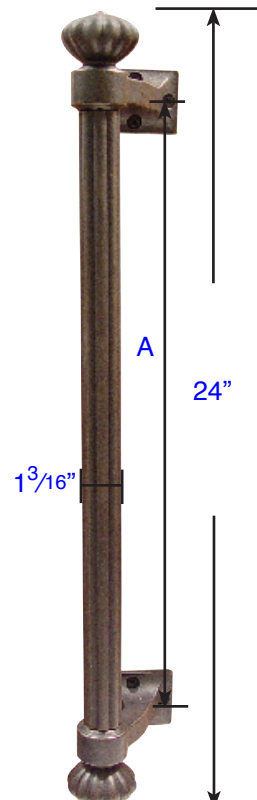

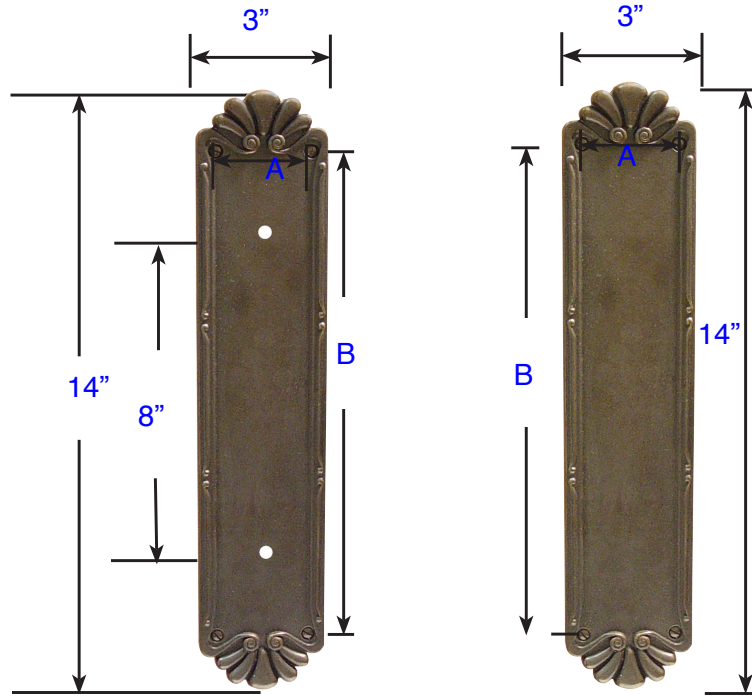

Tuscany Petal
Pull Plate (86182)
Plate only
drilled to accept 8" pull

Tuscany Petal
Push Plate (86181)

A = 2⁵/₃₂" Screw-to-Screw
B = 11¹/₄" Screw-to-Screw

A = 2⁵/₃₂" Screw-to-Screw
B = 11¹/₄" Screw-to-Screw

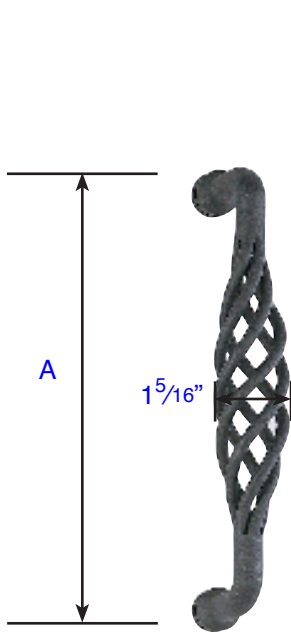

Lafayette (76030)

A = $8^{13/16}$ "
 Projection: $2^{1/2}$ "
 Base: $3/4$ " Diameter

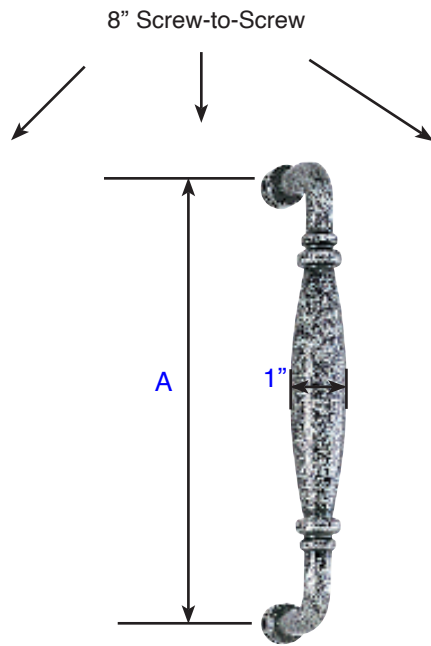

Normandy (76031)

A = $8^{13/16}$ "
 Projection: $2^{1/2}$ "
 Base: $3/4$ " Diameter

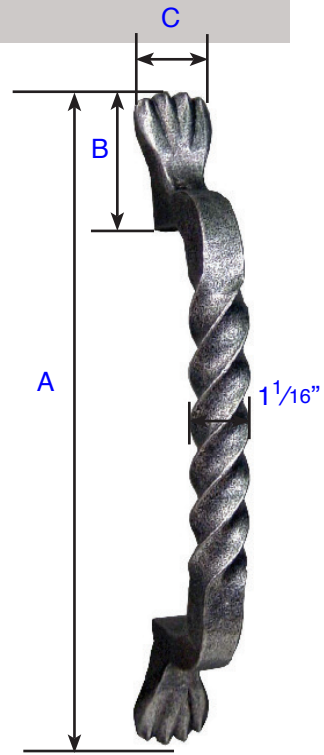

San Carlos 8" (76028)

A = $12^{1/4}$ ", B = $2^{1/2}$ ", C = $1^{1/8}$ "
 Projection: $2^{7/16}$ "

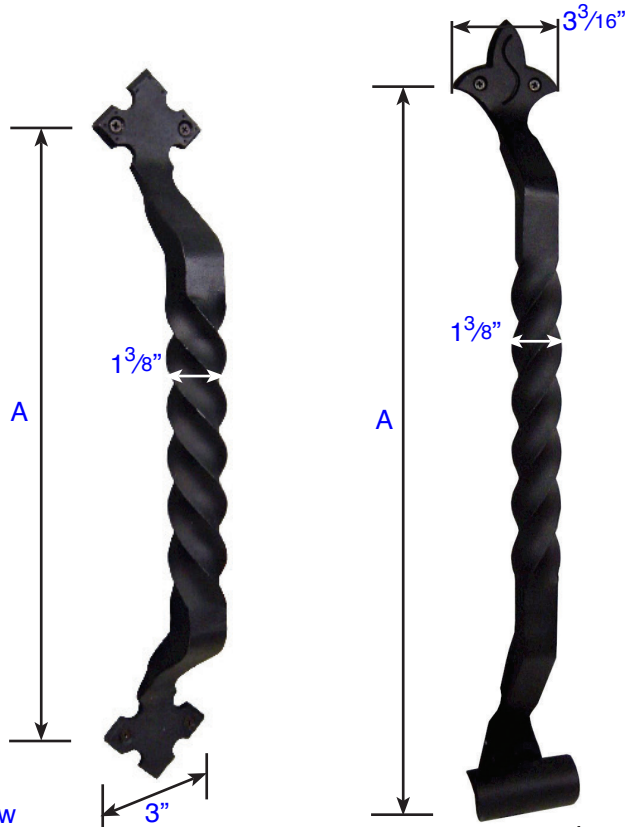

A = $14^{3/4}$ " Screw-to-Screw
 Projection: 3"

San Carlos, 18" (76029)

A = $21^{15/16}$ " Screw-to-Screw
 Projection: 3"

San Carlos, 24" (76041)

**Screw Specifications
 Wrought Steel 8" Pulls**

Standard Components:

- 1", 10-32 Screws
- 1", 1/4"-20 Screws
- Inserts for 1/4"-20 screws
- Inserts for 10-32 screws

**Screw Specifications
 Wrought Steel 18" & 24" Pulls**

Standard Components:

- #10, 1" Wood Screws